

PRZEKRÓJ J-J



Tolerancja wymiarowa $\pm 0,5$ mm

maxPCB: 193x119 mm

Elementy składowe:

- korpus
- pokrywa
- uszczelka
- 4x wkręt M4

Format

A3

Skala

1:2

Nr Produktu

TH - 256



MASZCZYK®

OBUDOWY DLA ELEKTRONIKI

„MASZCZYK”
05-071 Sulejówek-Miłosna
ul. Mickiewicza 10
tel: (22) 783-45-20 kom: 602-726-086

korpus

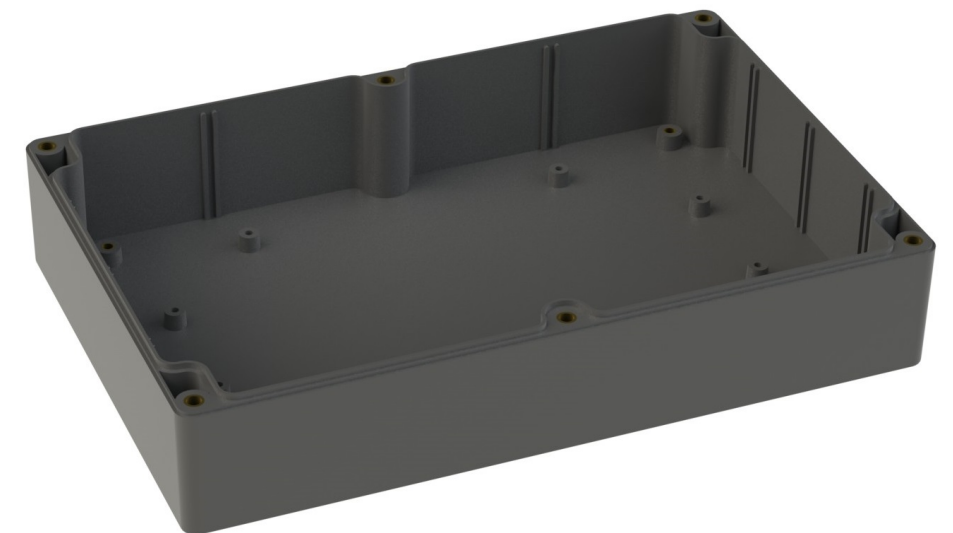
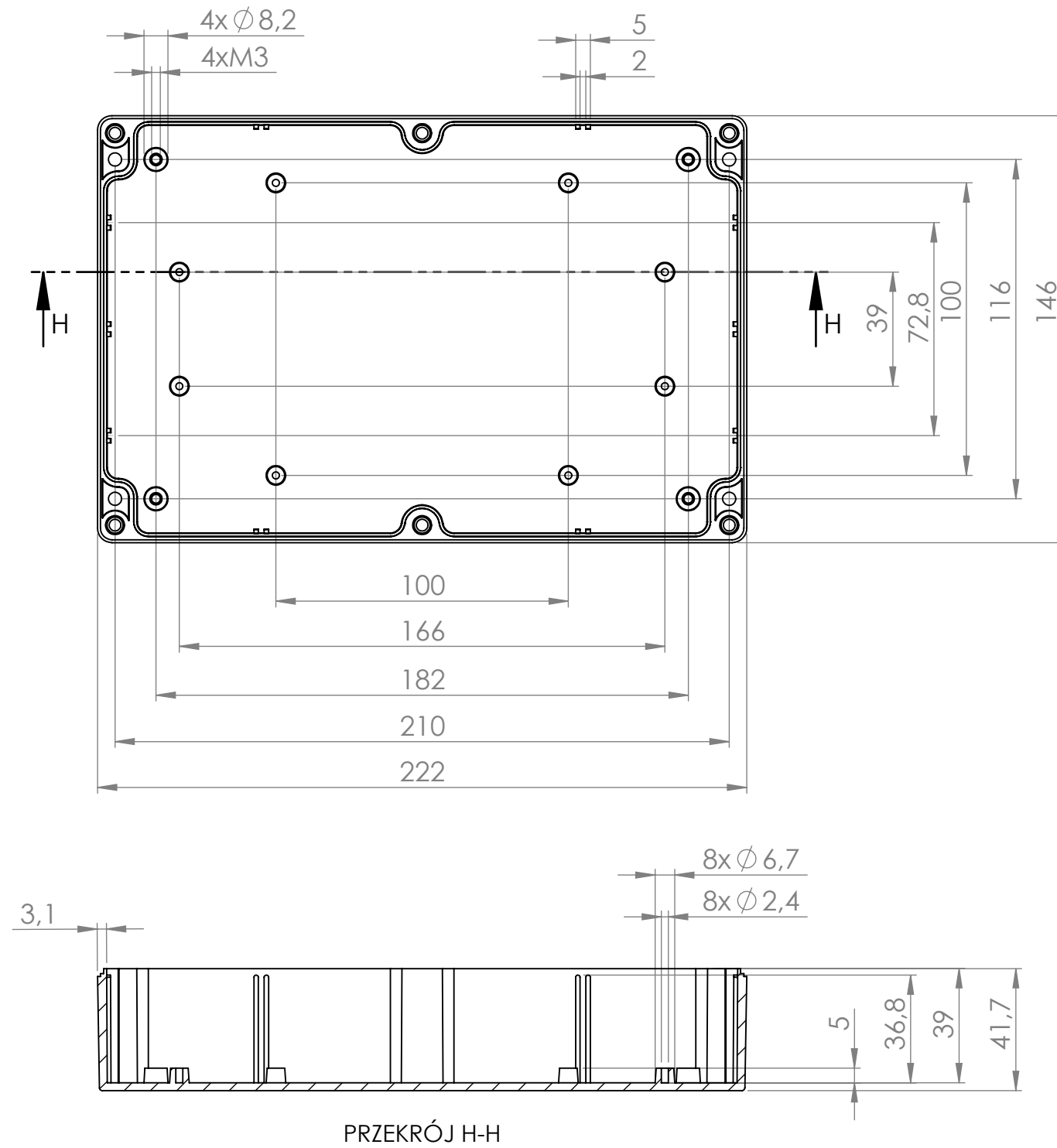

Tolerancja wymiarowa $\pm 0,5$ mm

Format	Skala	 MASZCZYK [®] OBUDOWY DLA ELEKTRONIKI
A3	1:2	
Nr Produktu	„MASZCZYK” 05-071 Sulejówek-Miłosna ul. Mickiewicza 10 tel: (22) 783-45-20 kom: 602-726-086	
TH - 256		

pokrywa

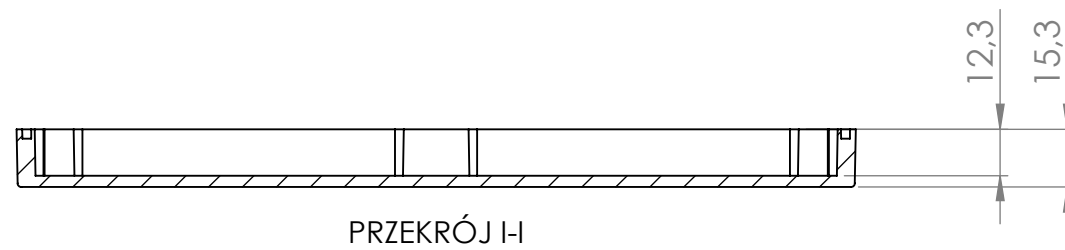
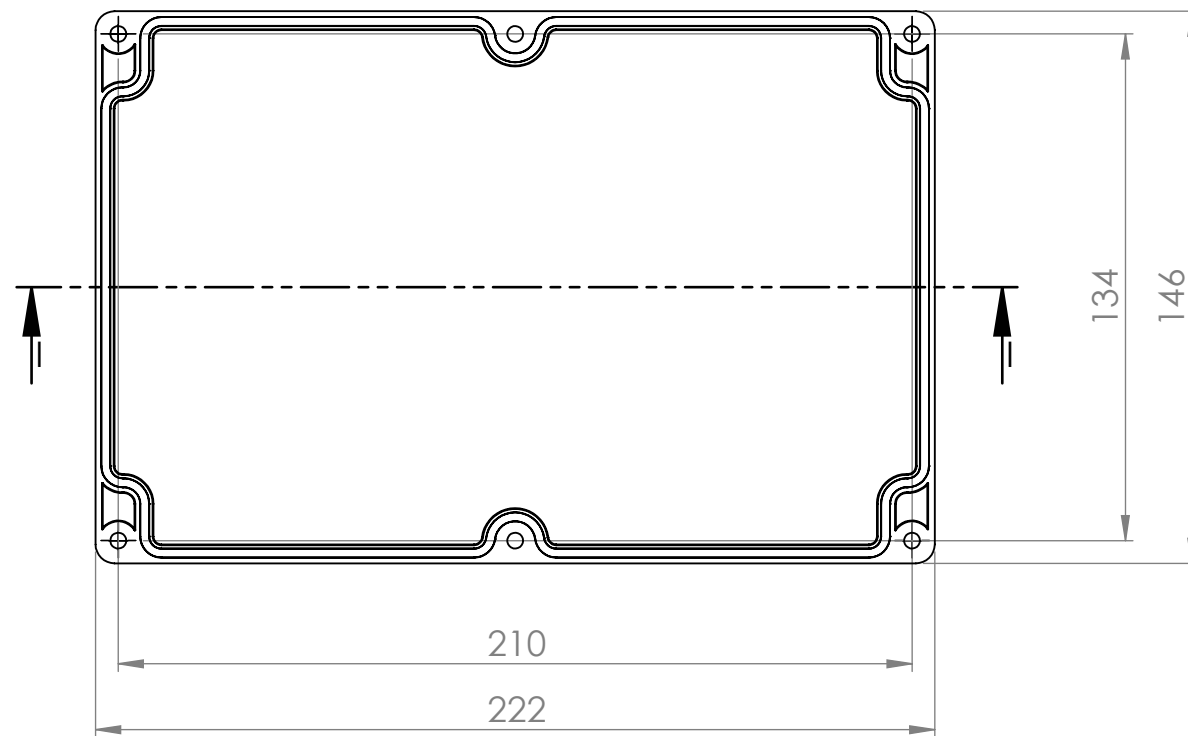

Tolerancja wymiarowa $\pm 0,5$ mm

Format	Skala		MASZCZYK [®] OBUDOWY DLA ELEKTRONIKI
A3	1:2		
Nr Produktu	„MASZCZYK” 05-071 Sulejówek-Miłosna ul. Mickiewicza 10 tel: (22) 783-45-20 kom: 602-726-086		
TH - 256			