

PRZEKRÓJ A-A



Tolerancja wymiarowa $\pm 0,5$ mm

Elementy składowe:
 - korpus
 - pokrywa
 - uszczelka
 - 4x wkręt M4

Format	Skala
A4	1:2
Nr produktu	
TH - 232	



„MASZCZYK”
 05-071 Sulejówek-Miłosna
 ul. Mickiewicza 10
 tel: (22) 783-45-20 kom: 602-726-086

korpus

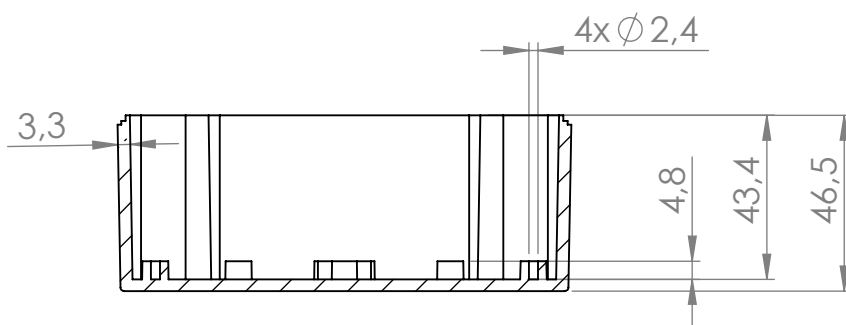
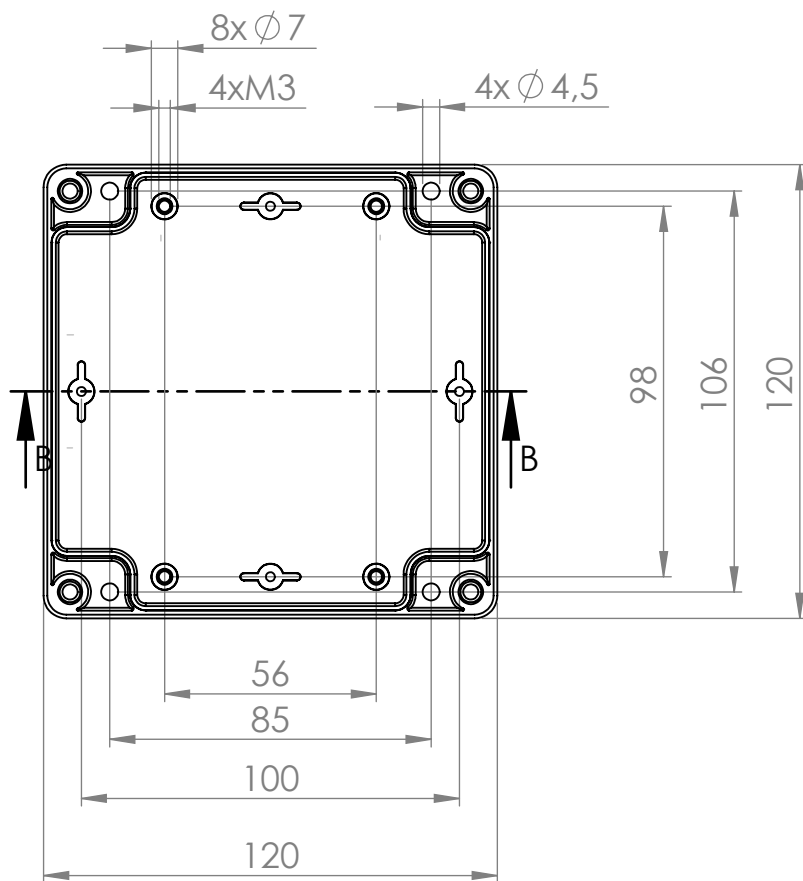

PRZEKRÓJ B-B



Tolerancja wymiarowa $\pm 0,5$ mm

Format A4	Skala 1:2
Nr produktu TH - 232	



„MASZCZYK”
05-071 Sulejówek-Miłosna
ul. Mickiewicza 10
tel: (22) 783-45-20 kom: 602-726-086

pokrywa

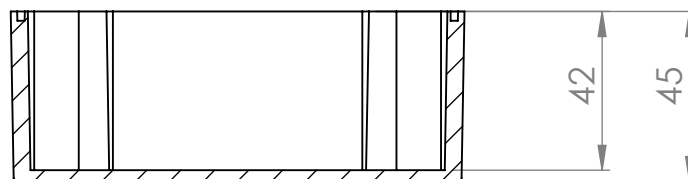
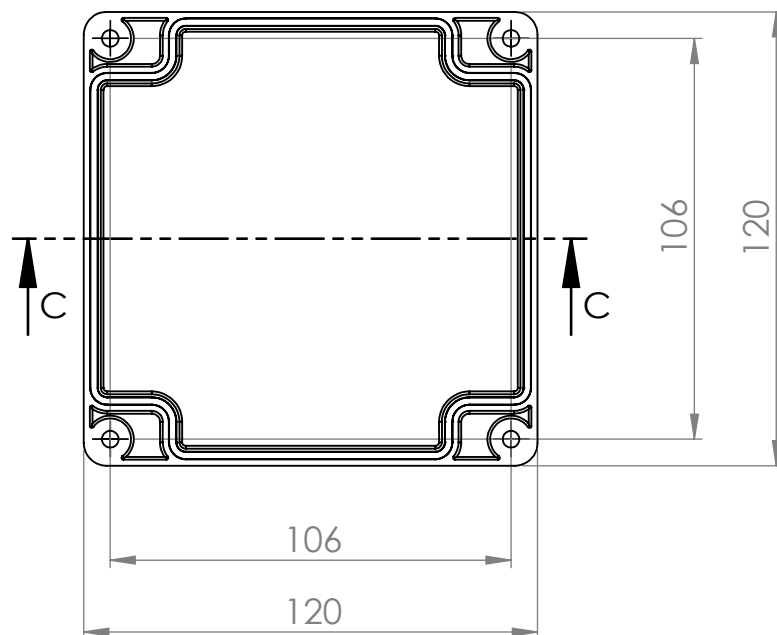

PRZEKRÓJ C-C

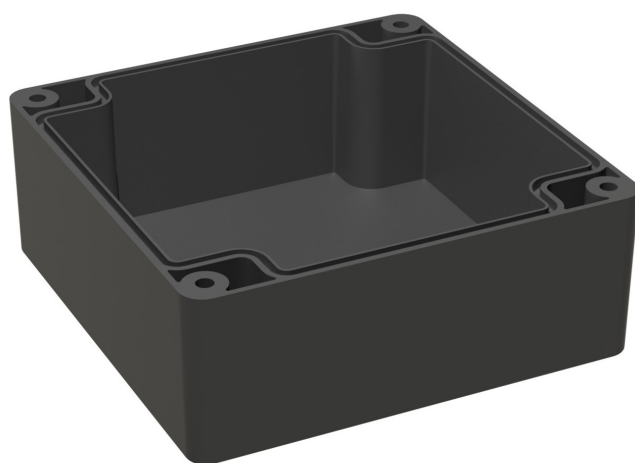

Tolerancja wymiarowa $\pm 0,5$ mm

Format A4	Skala 1:2
Nr produktu TH - 232	



„MASZCZYK”
05-071 Sulejówek-Miłosna
ul. Mickiewicza 10
tel: (22) 783-45-20 kom: 602-726-086