

PRZEKRÓJ A-A



Tolerancja wymiarowa  $\pm 0,5$  mm

Elementy składowe:

- korpus
- pokrywa
- uszczelka
- 4x wkręt M4

Format	Skala
A4	1:2
Nr produktu	
TH - 230	



„MASZCZYK”  
 05-071 Sulejówek-Miłosna  
 ul. Mickiewicza 10  
 tel: (22) 783-45-20 kom: 602-726-086

korpus

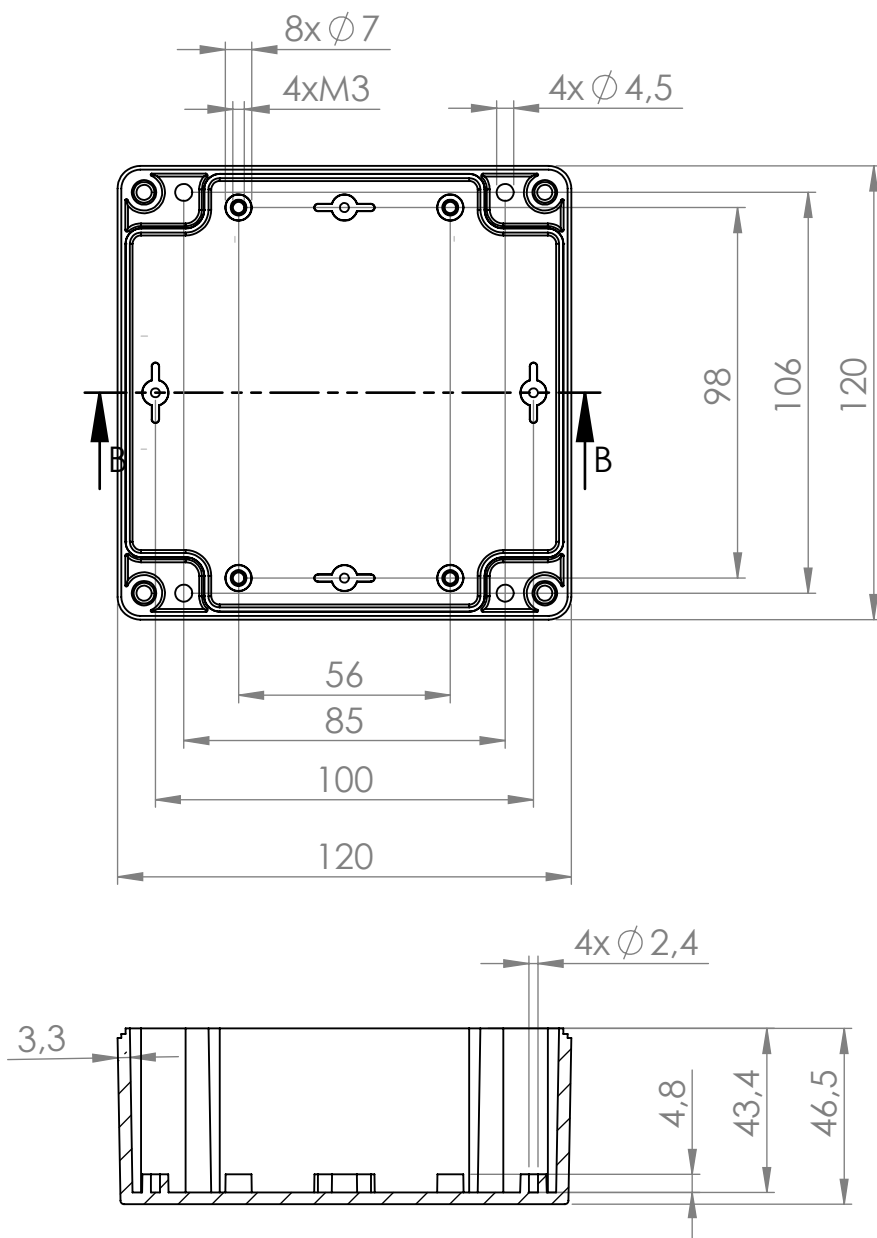

PRZEKRÓJ B-B



Tolerancja wymiarowa  $\pm 0,5$  mm

Format A4	Skala 1:2
Nr produktu TH - 230	



„MASZCZYK”  
05-071 Sulejówek-Miłosna  
ul. Mickiewicza 10  
tel: (22) 783-45-20 kom: 602-726-086

pokrywa

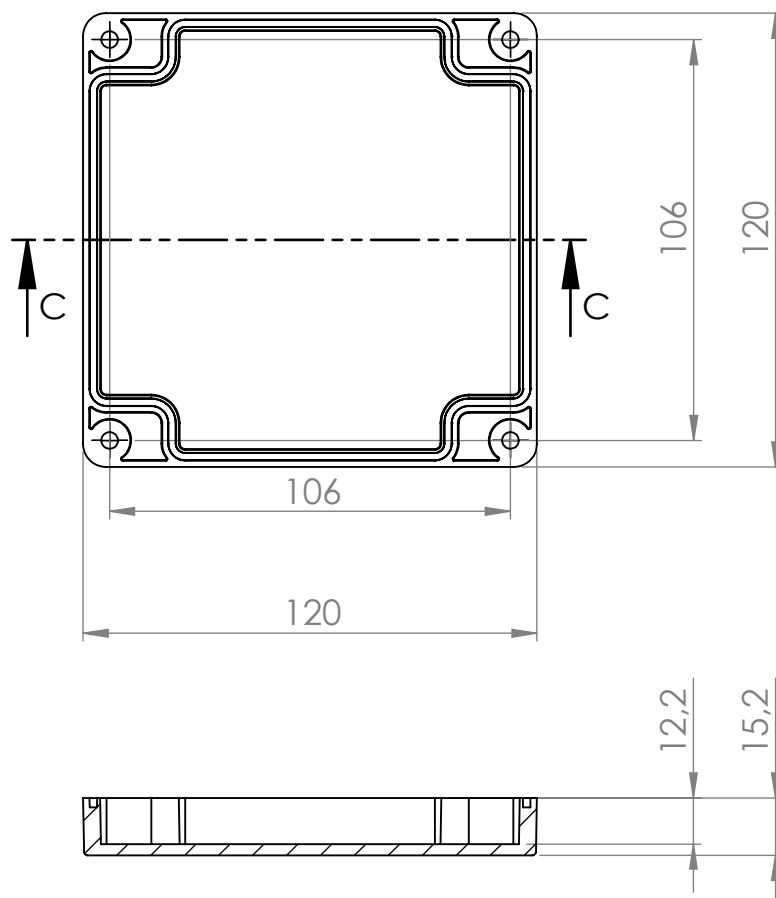

PRZEKRÓJ C-C

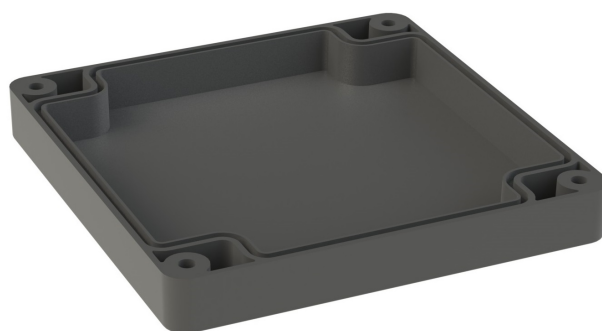

Tolerancja wymiarowa  $\pm 0,5$  mm

Format A4	Skala 1:2
Nr produktu TH - 230	



„MASZCZYK”  
05-071 Sulejówek-Miłosna  
ul. Mickiewicza 10  
tel: (22) 783-45-20 kom: 602-726-086