

PRZEKRÓJ A-A



Tolerancja wymiarowa $\pm 0,3$ mm

maxPCB: 212x134 mm

Elementy składowe:

- korpus
- pokrywa
- 6x wkręt M4
- uszczelka

Format

A3

Skala

1:2

Nr Produktu

TH - 260



MASZCZYK®

OBUDOWY DLA ELEKTRONIKI

„MASZCZYK”
05-071 Sulejówek-Miłosna
ul. Mickiewicza 10
tel: (22) 783-45-20 kom: 602-726-086

korpus

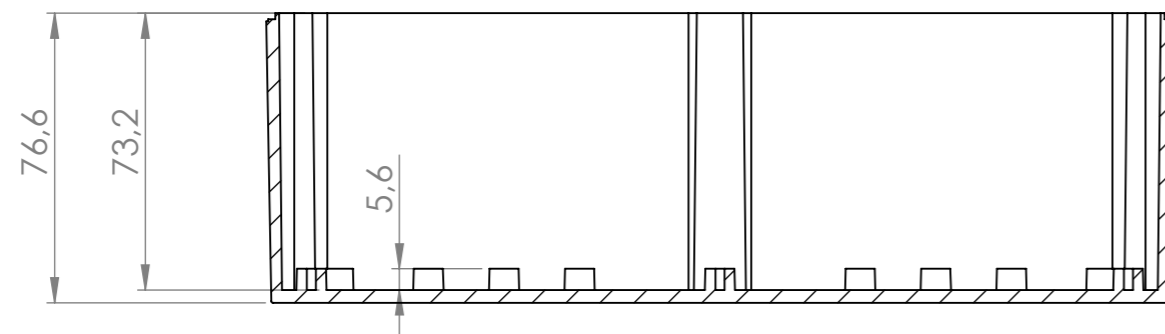
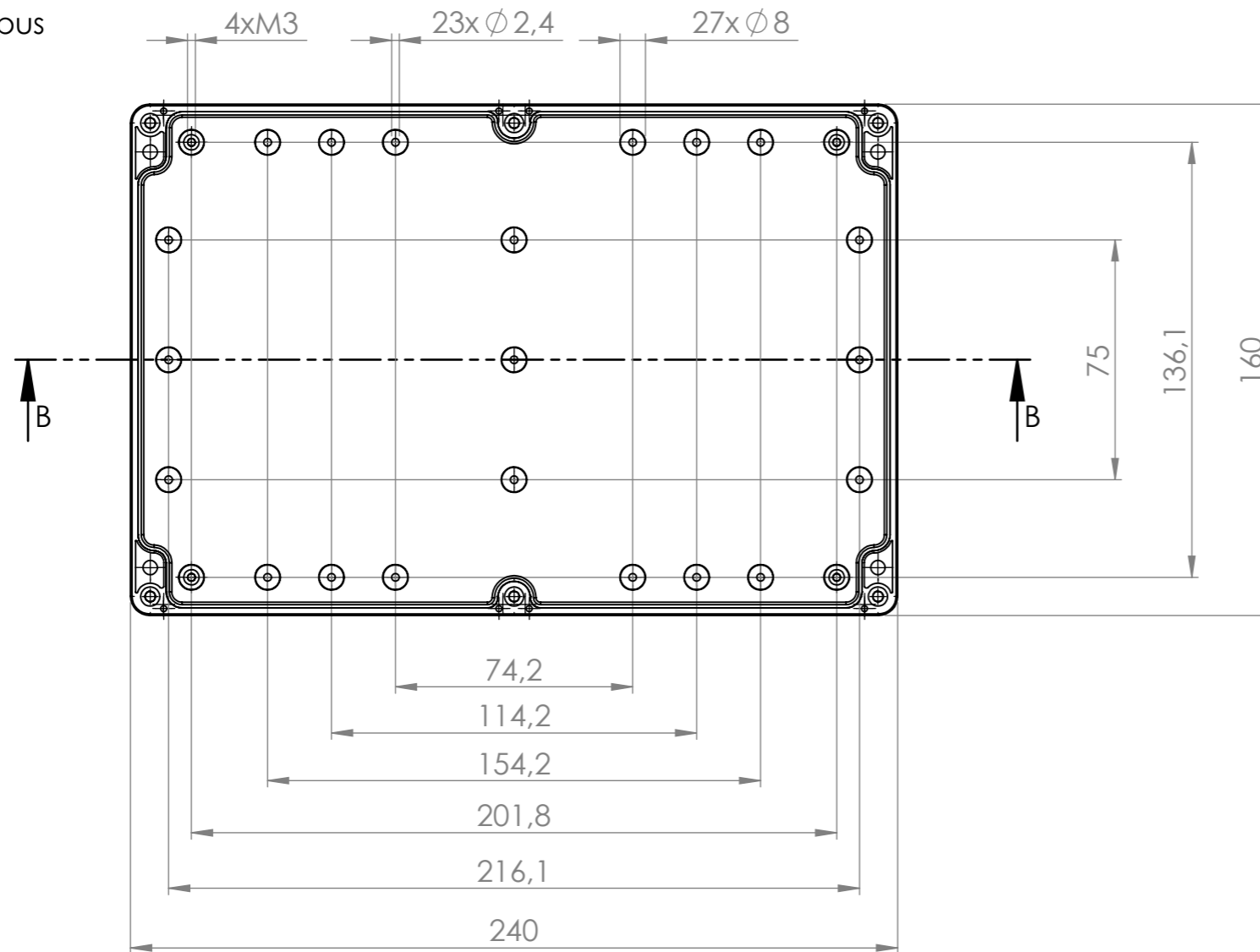

PRZEKRÓJ B-B

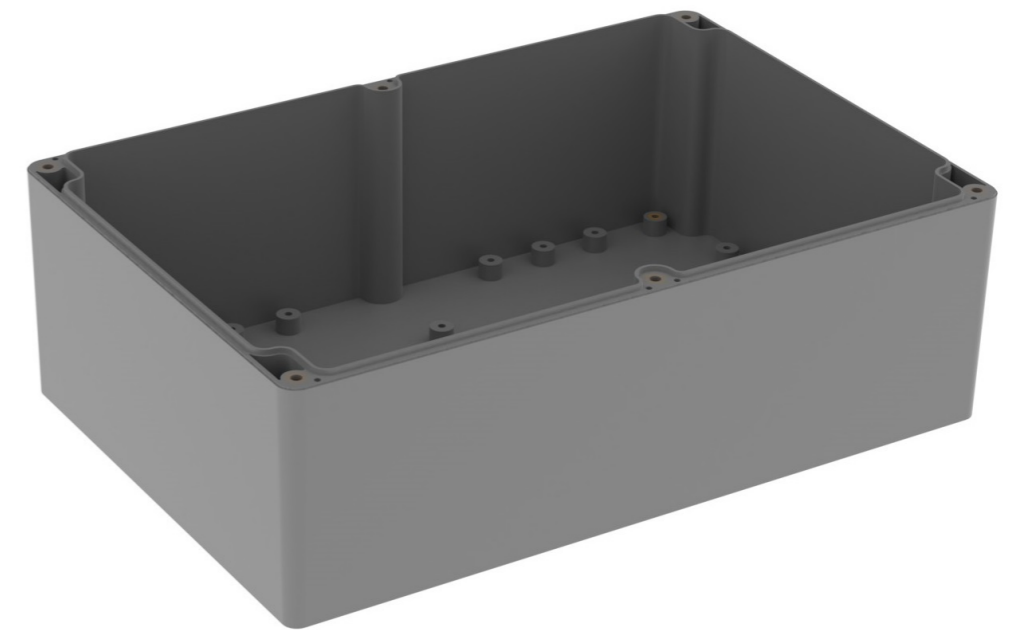

Tolerancja wymiarowa $\pm 0,3$ mm

Format	Skala	 MASZCZYK [®] OBUDOWY DLA ELEKTRONIKI
A3	1:2	
Nr Produktu	„MASZCZYK” 05-071 Sulejówek-Miłosna ul. Mickiewicza 10 tel: (22) 783-45-20 kom: 602-726-086	
TH - 260		

pokrywa

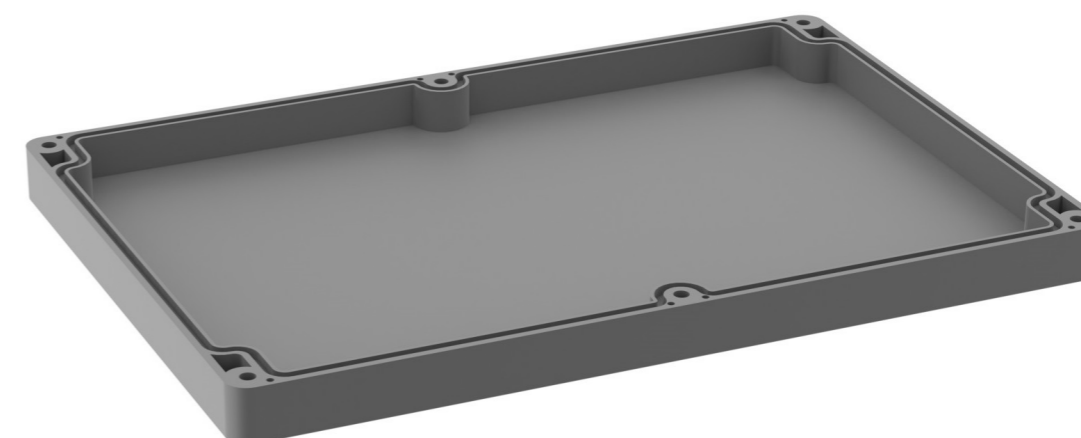
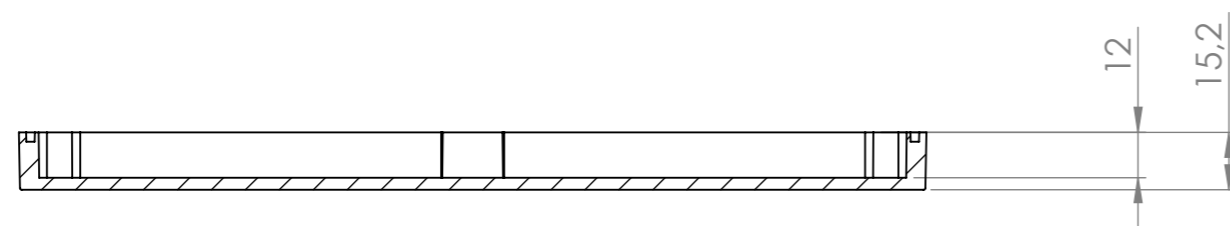
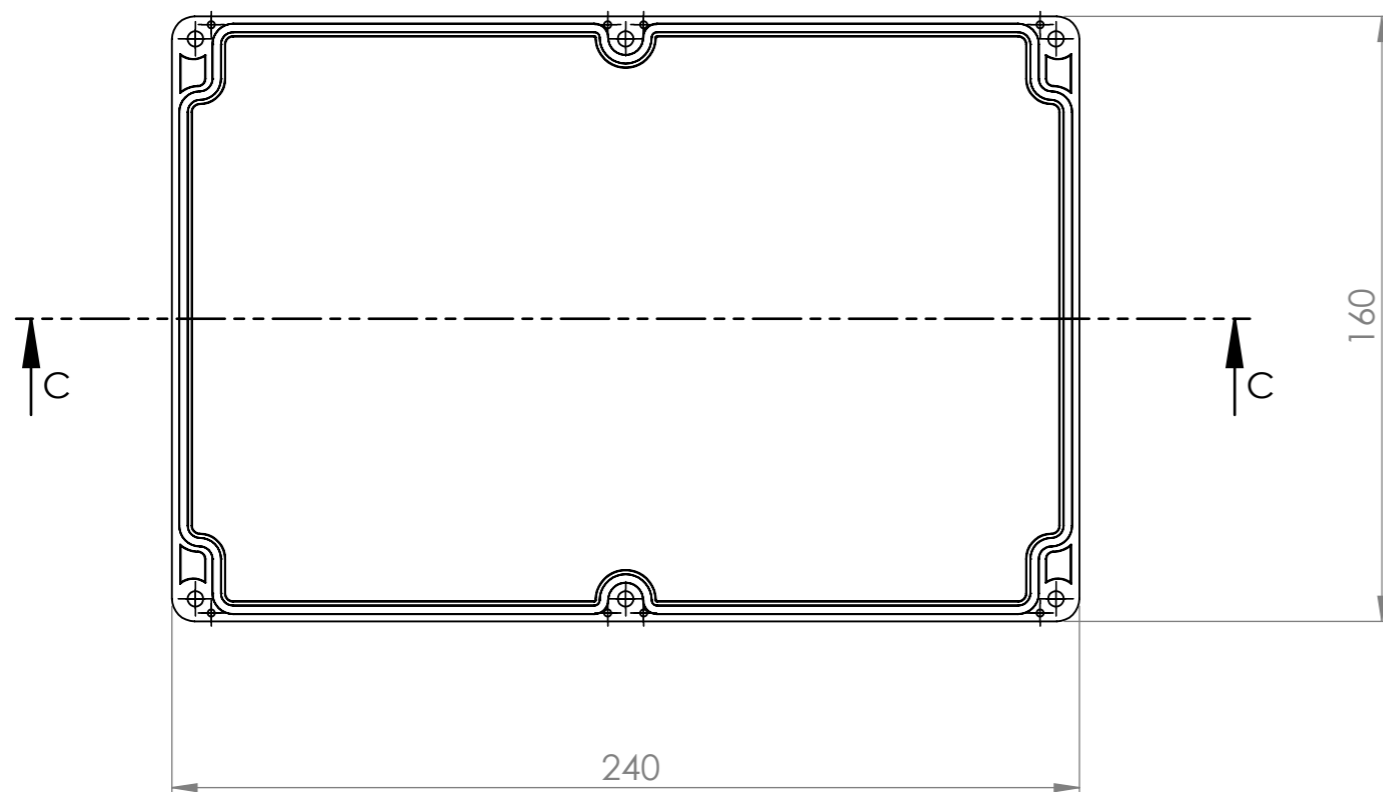

Tolerancja wymiarowa $\pm 0,3$ mm

Format	Skala	 MASZCZYK [®] OBUDOWY DLA ELEKTRONIKI
A3	1:2	
Nr Produktu	„MASZCZYK” 05-071 Sulejówek-Miłosna ul. Mickiewicza 10 tel: (22) 783-45-20 kom: 602-726-086	
TH - 260		