

PRZEKRÓJ A-A

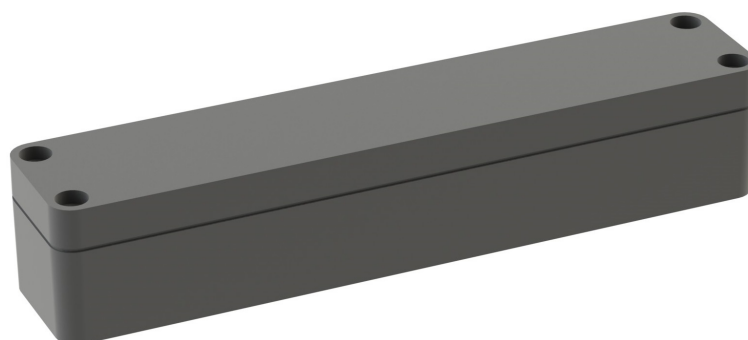

Tolerancja wymiarowa $\pm 0,5$ mm

maxPCB: 156x30,4 mm

Elementy składowe:

- korpus
- pokrywa
- uszczelka
- 4x wkręt M4

Format

A4

Skala

1:2

Nr produktu

TH - 208



MASZCZYK®

OBUDOWY DLA ELEKTRONIKI

„MASZCZYK”

05-071 Sulejówek-Miłosna

ul. Mickiewicza 10

tel: (22) 783-45-20 kom: 602-726-086

korpus

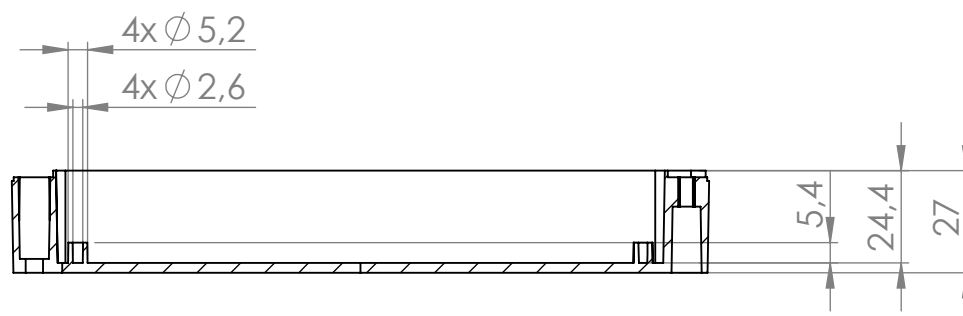
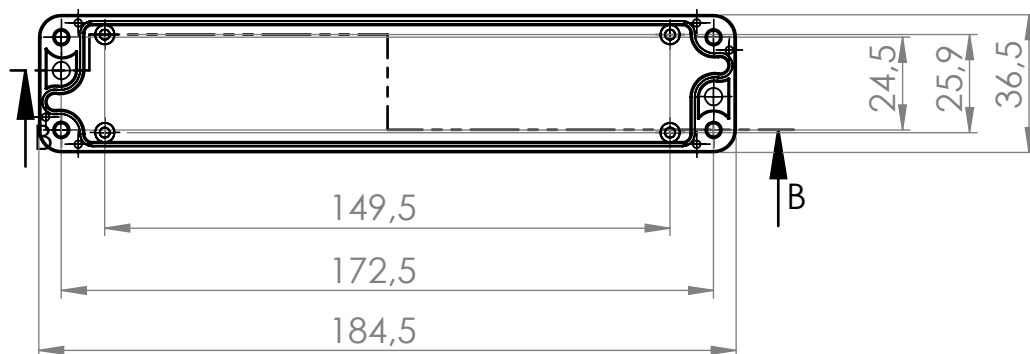

PRZEKRÓJ B-B

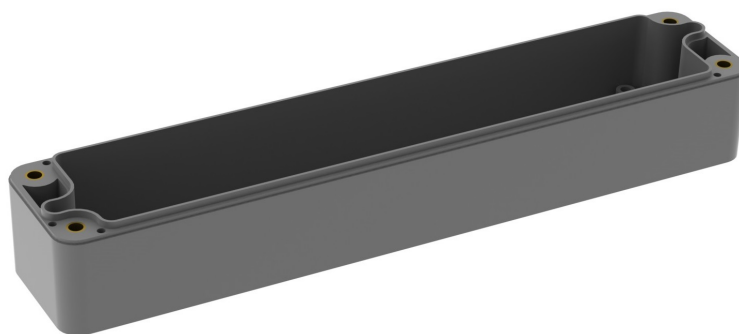

Tolerancja wymiarowa $\pm 0,5$ mm

Format
A4

Scale
1:2

Product No.

TH - 208



MASZCZYK[®]
PLASTIC ENCLOSURES

„MASZCZYK”
05-071 Sulejówek-Miłosna
ul. Mickiewicza 10
tel: (22) 783-45-20 kom: 602-726-086

pokrywa

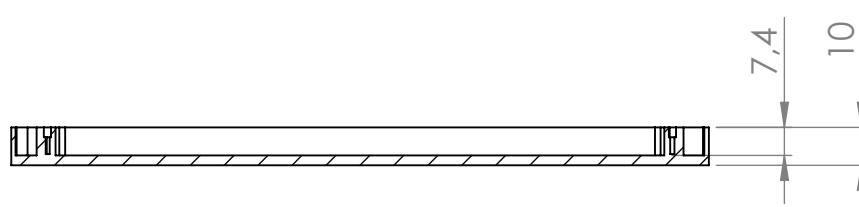
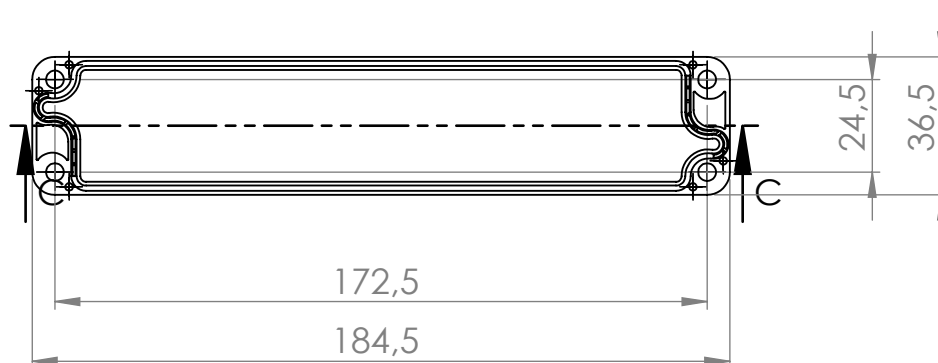

PRZEKRÓJ C-C

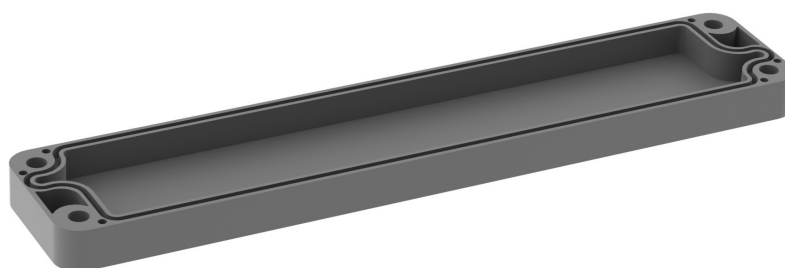

Tolerancja wymiarowa $\pm 0,5$ mm

Format A4	Scale 1:2	 MASZCZYK [®] PLASTIC ENCLOSURES „MASZCZYK” 05-071 Sulejówek-Miłosna ul. Mickiewicza 10 tel: (22) 783-45-20 kom: 602-726-086
Product No. TH - 208		